

# SFERA NEWFLUSH 50x35

**CATALANO**  
THE ESSENCE OF CERAMICS

cod. 1VSS50R00

Wc sospeso.  
Wall-hung WC.  
Wand-wc.

**newflush®**

Nuovo scarico senza brida.  
New flush without rim.  
Neue Spülung ohne Spülrand.

cod. 5KFST00

Kit fissaggio dal basso.  
Kit for bottom-side fixing.  
Kit für die Befestigung von unten.



 cod. 5SCSTP000 Soft Close Plus\*

 cod. 5SCSTF000 Soft Close\*

 cod. 5SCST000 Standard\*

 cod. 5ZECOF00 Soft Close\*



\* TakeOff System

 EN 997 - CL1 - 6A

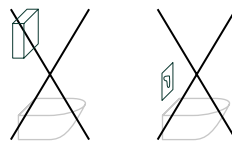
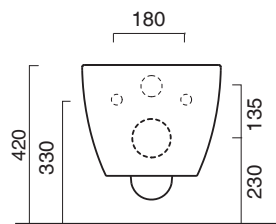
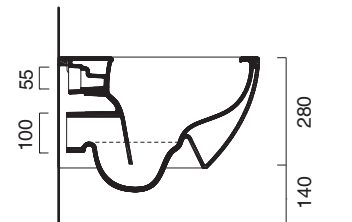
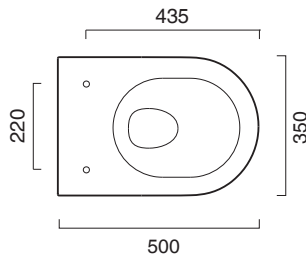

É sconsigliato l'abbinamento con cassetta tradizionale alta e flussometro.  
Not suitable for high level cistern and flush valve.  
Die Kombination mit Spülkästen niedriger Bauhöhe sowie Druckknopfspüler wird nicht empfohlen.

Per elevate prestazioni di scarico settare la cassetta a 6 litri.  
For high flushing performance, please set the cistern to 6 liters per flush.  
Um eine optimale Spülleistung zu gewährleisten empfiehlt Catalano die Wassermenge im Spülkasten auf 6L einzustellen.

Tutti i diritti sulla presente scheda appartengono a Ceramica Catalano S.p.A. in via esclusiva. È vietata la copia, la pubblicazione, la distribuzione o la riproduzione (anche parziale), se non autorizzata per iscritto.  
All rights in the present form belong exclusively to Ceramica Catalano S.p.A. It is strictly forbidden to copy, publish, distribute or reproduce it (including any partial reproduction), without prior written permission.

# newflush®

over silent, over clean.

tested by  
**TÜVRheinland**  
EN - 997  
6/4.5 L  
Patent pending  
Registered design



reddot award 2016 winner



## VORTEX FLUSHING

Tramite un flusso d'acqua a vortice, incrementa il comfort del prodotto riducendo in modo sensibile la rumorosità delle operazioni di scarico.

*The Newflush® water vortex optimises flushing performance and significantly reduces the sound of toilet flush..*

*Steigert durch einen wirbelartigen Wasserstrom die Spülleistung des WC's und verringert deutlich die Lärmbelastung der Toilettenspülung.*



## RIMLESS

L'eliminazione della brida garantisce maggiore continuità delle superfici del wc permettendo azioni di pulizia più semplici e approfondite, con minore utilizzo dei detersivi.

*The removal of the rim ensures visual continuity of the surfaces and allows for easier and deeper cleaning requiring less detergents.*

*Der Verzicht auf den traditionellen Spülrand garantiert eine bessere Verteilung des Wassers und ermöglicht gleichzeitig eine gründlichere und einfachere Reinigung des WC's.*

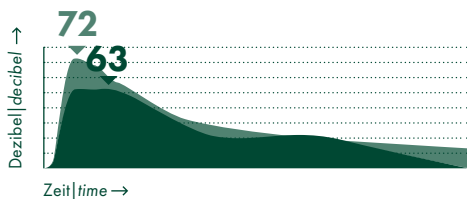
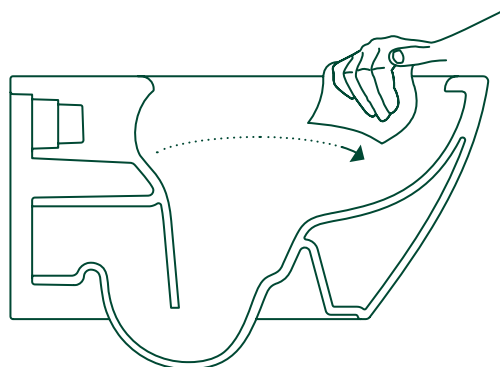
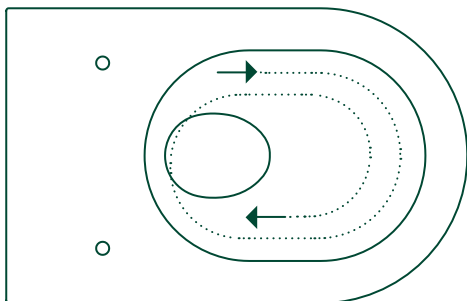

Newflush®



Traditionell Wc  
Traditional Rim

● Newflush®

● Traditionell Wc | Traditional Rim



CATAGLAZE



GLAZED SIPHON



HIDDEN FIXING SYSTEM



TAKE-OFF SYSTEM



SOFT CLOSE

MADE IN ITALY

## GARANZIA

Il rivenditore sostituirà i prodotti con difetti di fabbricazione entro due anni dalla consegna.

*Your retailer will replace products with faults of manufacturing within two years from delivery date.*

*Der Wiederverkäufer wird Produkte mit Fabrikationsfehlern innerhalb 2 Jahren seit Zustellung ersetzen.*

## PULIZIA

Si consiglia di pulire con acqua tiepida e detersivo non abrasivo.

*The maintenance has to be done with tepid water and not abrasive detergents.*

*Für die Reinigung empfiehlt sich lauwarmes Wasser und keine Scheuermittel zu verwenden.*

## DICHIARAZIONE DI PERFORMANCE - DOP No 997

Scarica il documento al seguente link a lato:

*Click the link on the side to download the document:*

*Klicken Sie auf den Link zum Herunterladen des Dokuments:*

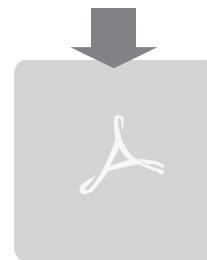

## WATER LABEL

Una nuova etichetta informativa accompagna i WC Catalano, attribuita e certificata dalla The Water Label Company. L'etichetta mostra una classificazione di performance, indicando il volume massimo d'acqua che il wc utilizza nella fase di scarico.

*All Catalano WCs have a new label, certified and issued by The Water Label Company. The label shows a performance ranking, indicating the maximum water volume of the toilet's flush.*

*Die Catalano-WCs besitzen eine neue Zertifizierung, die von der Water Label Company vergeben wird. Die Zertifizierung stellt eine Leistungsklassifizierung dar und gibt das maximale Wasservolumen an, das ein WC bei der Spülung verbraucht.*

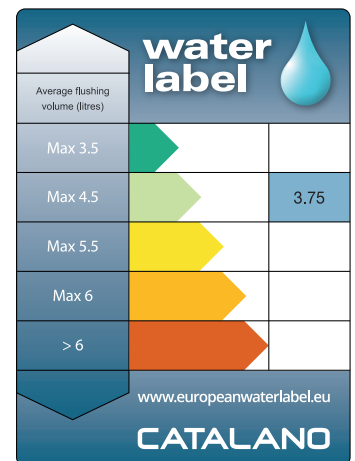

## KIT DI FISSAGGIO

Installabile esclusivamente su barre m 12 e con apposito kit di fissaggio dal basso.

*For m 12 threaded bars only use proper bottom-side fixing sets.*

*Nur auf barren m12 mit dafür vorgesehenem Befestigungsset installierbar.*

vedi il video al seguente link a lato:

*Click the picture on the right to watch the video:*

*Klicke auf das Bild rechts, um das Video anzuschauen:*

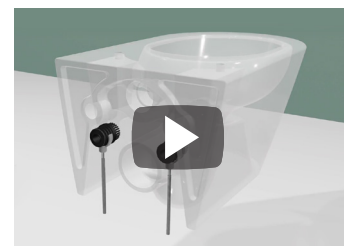

Antibacterial protection

**CATAglaze<sup>®</sup> + Silver Titanium**

**CATALANO**  
THE ESSENCE OF CERAMICS

MADE IN ITALY

L'INNOVATIVO SMALTO ANTIBATTERICO SU TUTTA LA CERAMICA  
THE INNOVATIVE ANTIBACTERIAL GLAZE IS STANDARD ON ALL  
CATALANO PRODUCTS.

L'ÉMAIL ANTIBACTÉRIEN NOVATEUR SUR TOUTE LA CÉRAMIQUE

IT È un potenziamento dello smalto Cataglaze che, oltre a ridurre il deposito di calcare facilitando la pulizia dei sanitari ceramici, svolge una potente azione antimicrobica in grado di contrastare germi e batteri. L'efficacia della nuova formula è garantita dalla presenza nell'impasto di ioni d'argento e di titanio. L'azione antibatterica è certificata ISO 22196 con efficacia del 99,99%.

EN It is an improvement of Cataglaze glazing system; besides being more resistant to limescale and therefore easier to clean, it has a powerful antimicrobial action able to kill germs and bacteria. The effectiveness of the new formula is guaranteed by the presence in the mix of silver and titanium ions. The antibacterial action is ISO 22196 certified and it is 99.99% effective.

FR Il s'agit d'un renforçant de l'émail Cataglaze qui, en plus de réduire le dépôt de calcaire et donc faciliter le nettoyage des sanitaires en céramique, exerce une action antimicrobienne puissante en mesure de contraster les germes et les bactéries. L'efficacité de la nouvelle formule est garantie par la présence, dans le mélange, d'ions d'argent et de titane. L'action antibactérienne est certifiée ISO 22196 avec une efficacité de 99,99%.



Silver Titanium  
Protezione antibatterica  
Silver Titanium  
Antibacterial protection  
Silver Titanium  
Protection antibactérienne

**99,99%**

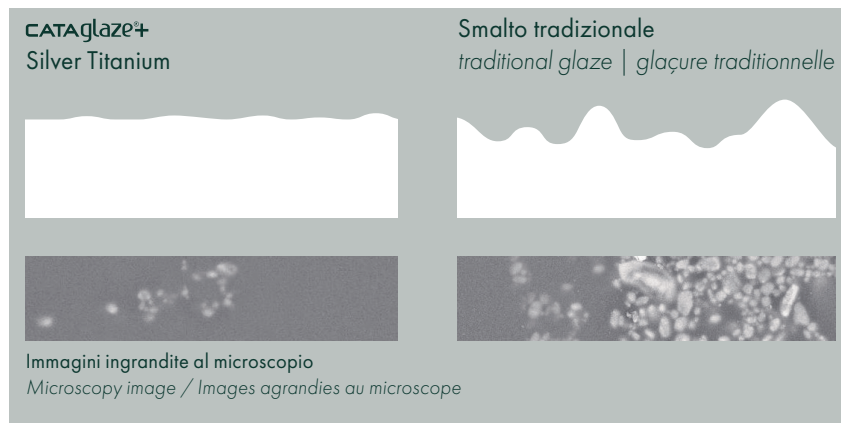

Maggiore brillantezza  
Brightness  
Aspect brillant



Resistenza agli agenti chimici  
Resistance to chemicals  
Résistant aux agents chimiques



Rispetto per l'ambiente  
Respect for the environment  
Respect de l'environnement



Pulizia facile e rapida  
Quick cleaning  
Nettoyage rapide



Igiene totale  
Total hygiene  
Hygiène totale



Lunga durata di vita  
Long lifecycle  
Longue durée

Tutti i diritti sulla presente scheda appartengono a Ceramica Catalano S.p.A. in via esclusiva. È vietata la copia, la pubblicazione, la distribuzione o la riproduzione (anche parziale), se non autorizzata per iscritto. All rights in the present form belong exclusively to Ceramica Catalano S.p.A. It is strictly forbidden to copy, publish, distribute or reproduce it (including any partial reproduction), without prior written permission.

# SFERA 50x35

**CATALANO**  
THE ESSENCE OF CERAMICS

cod. 1BSS5000

Bidet sospeso monoforo.  
Wall-hung single-hole bidet.  
Einloch-Hängebidet.

cod. 5KFST00

Kit fissaggio dal basso.  
Kit for bottom-side fixing.  
Kit für die Befestigung von unten.



**CE** EN 14528 - CL20

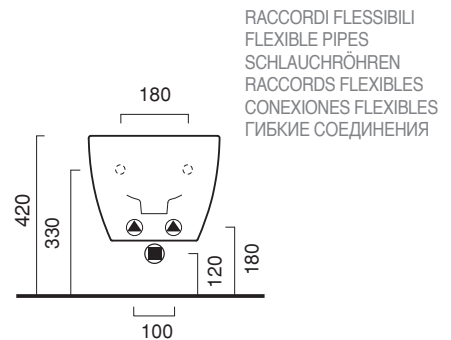
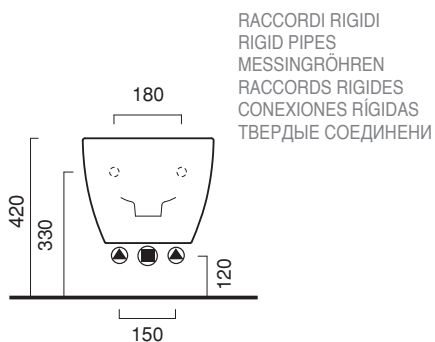
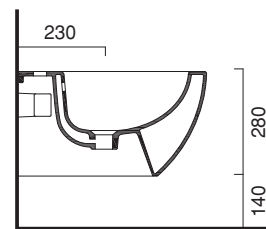
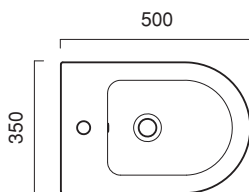

Tutti i diritti sulla presente scheda appartengono a Ceramica Catalano S.p.A. in via esclusiva. È vietata la copia, la pubblicazione, la distribuzione o la riproduzione (anche parziale), se non autorizzata per iscritto.  
All rights in the present form belong exclusively to Ceramica Catalano S.p.A. It is strictly forbidden to copy, publish, distribute or reproduce it (including any partial reproduction), without prior written permission.

MADE IN ITALY

## GARANZIA

Il rivenditore sostituirà i prodotti con difetti di fabbricazione entro due anni dalla consegna.

*Your retailer will replace products with faults of manufacturing within two years from delivery date.*

*Der Wiederverkäufer wird Produkte mit Fabrikationsfehlern innerhalb 2 Jahren seit Zustellung ersetzen.*

## PULIZIA

Si consiglia di pulire con acqua tiepida e detersivo non abrasivo.

*The maintenance has to be done with tepid water and not abrasive detergents.*

*Für die Reinigung empfiehlt sich lauwarmes Wasser und keine Scheuermittel zu verwenden.*

---

## DICHIARAZIONE DI PERFORMANCE - DOP N° 14528

Scarica il documento al seguente link a lato:

*Click the link on the side to download the document:*

*Klicken Sie auf den Link zum Herunterladen des Dokuments:*

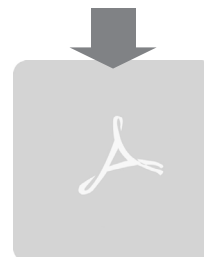

---

## KIT DI FISSAGGIO

Installabile esclusivamente su barre m 12 e con apposito kit di fissaggio dal basso.

*For m 12 threaded bars only use proper bottom-side fixing sets.*

*Nur auf barren m12 mit dafür vorgesehenem befestigungsset installierbar.*

vedi il video al seguente link a lato:

*Click the picture on the right to watch the video:*

*Klicke auf das Bild rechts, um das Video anzuschauen:*



Antibacterial protection

**CATAglaze<sup>®</sup> + Silver Titanium**

**CATALANO**  
THE ESSENCE OF CERAMICS

MADE IN ITALY

L'INNOVATIVO SMALTO ANTIBATTERICO SU TUTTA LA CERAMICA  
THE INNOVATIVE ANTIBACTERIAL GLAZE IS STANDARD ON ALL  
CATALANO PRODUCTS.

L'ÉMAIL ANTIBACTÉRIEN NOVATEUR SUR TOUTE LA CÉRAMIQUE

**IT È un potenziamento dello smalto Cataglaze che, oltre a ridurre il deposito di calcare facilitando la pulizia dei sanitari ceramici, svolge una potente azione antimicrobica in grado di contrastare germi e batteri. L'efficacia della nuova formula è garantita dalla presenza nell'impasto di ioni d'argento e di titanio. L'azione antibatterica è certificata ISO 22196 con efficacia del 99,99%.**

**EN It is an improvement of Cataglaze glazing system; besides being more resistant to limescale and therefore easier to clean, it has a powerful antimicrobial action able to kill germs and bacteria. The effectiveness of the new formula is guaranteed by the presence in the mix of silver and titanium ions. The antibacterial action is ISO 22196 certified and it is 99.99% effective.**

**FR Il s'agit d'un renforcement de l'émail Cataglaze qui, en plus de réduire le dépôt de calcaire et donc faciliter le nettoyage des sanitaires en céramique, exerce une action antimicrobienne puissante en mesure de contraster les germes et les bactéries. L'efficacité de la nouvelle formule est garantie par la présence, dans le mélange, d'ions d'argent et de titane. L'action antibactérienne est certifiée ISO 22196 avec une efficacité de 99,99%.**



Silver Titanium  
Protezione antibatterica  
Silver Titanium  
Antibacterial protection  
Silver Titanium  
Protection antibactérienne

**99,99%**

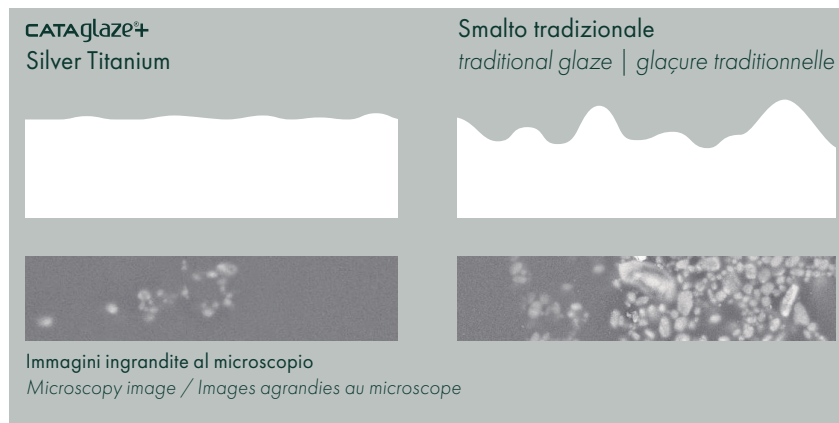

Maggiore brillantezza  
Brightness  
Aspect brillant



Resistenza agli agenti chimici  
Resistance to chemicals  
Résistant aux agents chimiques



Rispetto per l'ambiente  
Respect for the environment  
Respect de l'environnement



Pulizia facile e rapida  
Quick cleaning  
Nettoyage rapide



Igiene totale  
Total hygiene  
Hygiène totale



Lunga durata di vita  
Long lifecycle  
Longue durée

Tutti i diritti sulla presente scheda appartengono a Ceramica Catalano S.p.A. in via esclusiva. È vietata la copia, la pubblicazione, la distribuzione o la riproduzione (anche parziale), se non autorizzata per iscritto. All rights in the present form belong exclusively to Ceramica Catalano S.p.A. It is strictly forbidden to copy, publish, distribute or reproduce it (including any partial reproduction), without prior written permission.